

Wall mounting socket outlet - housing dimensions 170x118



Product description	
BALS-Prd.-Nr	1127
EAN	4024941011273
Product category	Wall mounting socket outlet
Current	63A
Number of poles	4p
Arrangement of phases	3P+PE
Position of earth contact	6 h
Voltage	380 - 415V~

Product description	
Frequency	50/60Hz
Protection degree	IP44
Colour code	red RAL 3000
Colour of appliance	Hinged lid red RAL 3000, Housing bottom grey RAL 7035, Housing top grey RAL 7035
Connection design	screw terminal as box terminal with Kontex-contact
Maximum conductor size	25.0 qmm
Cable entry	top entry M40 bottom entry M32
Height	226mm
Width	118mm
Depth	173mm
Dimension of enclosure	170x118 mm (HxW)
Material of enclosure	Polycarbonate
Contacts	the contact carrier is made of high temperature resistant material, the contacts are brass nickel plated

Additional technical information	
	The cable entry is one at top open and two at bottom closed
	Lower part of housing rotatable by 180°

Logistics data	
Weight/pcs	0.795 kg / Piece

Logistics data	
Packaging	Bag
Content amount	1 ST
EAN	4024941011273
Length	173 mm
Width	118 mm
Height	226 mm
Weight	0.796 kg
Volume	4,613.564 ccm
Packaging	Carton
Content amount	5 ST
EAN	4024941946469
Length	345 mm
Width	345 mm
Height	217 mm
Weight	4.31 kg
Volume	24,276 ccm

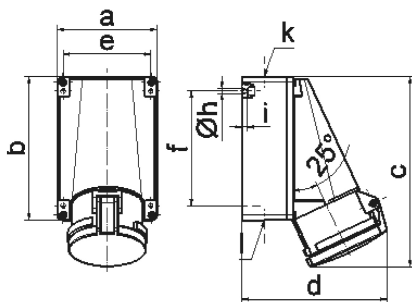

Ampere Polzahl	63 3	63 4	63 5			
a	118,0	118,0	118,0			
b	170,0	170,0	170,0			
c	223,0	223,0	223,0			
d	168,0	168,0	168,0			
e	104,0	104,0	104,0			
f	136,0	136,0	136,0			
h ø	6,1	6,1	6,1			
i	6,0	6,0	6,0			
k	M40	M40	M40			
l	M 32/32	M 32/32	M 32/32			
Leiter mm ² min	6	6	6			
Leiter mm ² max	25	25	25			