

panel mounting socket outlet, angled - flange 100x92,
fixing centers 85x77



Product description	
BALS-Prd.-Nr	12571
EAN	4024941125710
Product category	Panel mounting socket outlet, angled
Current	63A
Number of poles	4p
Arrangement of phases	3P+PE
Position of earth contact	7 h
Voltage	480 - 500V~

Product description	
Frequency	50/60Hz
Protection degree	IP67
Colour code	red RAL 3000
Colour of appliance	Hinged lid red RAL 3000, Enclosure grey RAL 7035, Bayonet ring grey RAL 7035
Connection design	screw terminal as box terminal with Kontex-contact
Maximum conductor size	25.0 qmm
Cable entry	other
Height	120mm
Width	111mm
Depth	147mm
Flange size vertical in mm	100mm
Flange size horizontal in mm	92mm
Drill hole dist. vertical mm	85mm
Drill hole dist. horizontal mm	77mm
Material of enclosure	Polyamide
Contacts	The contact carrier is made of high temperature resistant material, the contacts are brass nickel plated

Additional technical information	
	The inclination is 15°

Logistics data	
Weight/pcs	0.595 kg / Piece
Packaging	Bag
Content amount	1 ST
EAN	4024941125710
Length	147 mm
Width	111 mm
Height	120 mm
Weight	0.596 kg
Volume	1,958.04 ccm
Packaging	Carton
Content amount	10 ST
EAN	4024941958691
Length	330 mm
Width	216 mm
Height	260 mm
Weight	6.176 kg
Volume	17,062.5 ccm

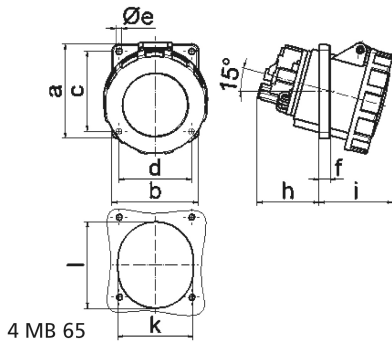

Ampere	63	63	63			
Polzahl	3	4	5			
a	100,0	100,0	100,0			
b	92,0	92,0	92,0			
c	85,0	85,0	85,0			
d	77,0	77,0	77,0			
e ø	6,5	6,5	6,5			
f	12,0	12,0	12,0			
h	65,0	65,0	65,0			
i	80,0	80,0	80,0			
k	80,0	80,0	80,0			
l	92,0	92,0	92,0			
Leiter mm ² min	6	6	6			
Leiter mm ² max	25	25	25			