

Panel mounting socket outlet straight - flange 75x75 fixing centers 60x60



Product description	
BALS-Prd.-Nr	13835
EAN	4024941138352
Product category	Panel mounting socket outlet QUICK-CONNECT, straight
Current	16A
Number of poles	5p
Arrangement of phases	3p+N+PE
Position of earth contact	6 h
Voltage	200/346 - 240/415V~

Product description	
Frequency	50/60Hz
Protection degree	IP44
Colour code	red RAL 3000
Colour of appliance	Hinged lid red RAL 3000, Enclosure grey RAL 7035
Connection design	screwless spring terminals with KONTEX-contact
Maximum conductor size	4,0 qmm
Cable entry	other
Height	86mm
Width	75mm
Depth	93mm
Flange size vertical in mm	75mm
Flange size horizontal in mm	75mm
Drill hole dist. vertical mm	60mm
Drill hole dist. horizontal mm	60mm
Material of enclosure	Polyamide
Contacts	the contact carrier is made of polyamide, the contacts are brass

Logistics data	
Weight/pcs	0.154 kg / Piece
Packaging	Bag
Content amount	1 ST

Logistics data	
EAN	4024941138352
Length	93 mm
Width	75 mm
Height	86 mm
Weight	0.155 kg
Volume	599.85 ccm
Packaging	Carton
Content amount	10 ST
EAN	4024941962827
Length	245 mm
Width	177 mm
Height	185 mm
Weight	1.673 kg
Volume	7,140 ccm

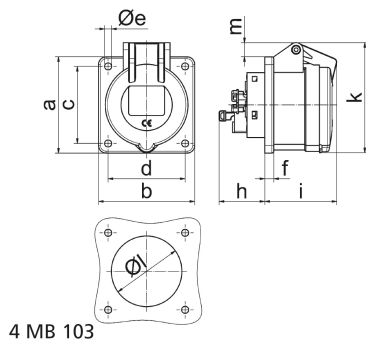

4 MB 103

Ampere Polzahl	16 3	16 4	16 5	32 3	32 4	32 5
a	75,0	75,0	75,0	75,0	75,0	75,0
b	75,0	75,0	75,0	75,0	75,0	75,0
c	60,0	60,0	60,0	60,0	60,0	60,0
d	60,0	60,0	60,0	60,0	60,0	60,0
e ø	5,5	5,5	5,5	5,5	5,5	5,5
f	7,0	7,0	7,0	8,0	8,0	8,0
h	35,5	35,5	35,5	50,0	50,0	50,0
i	52,0	53,0	57,0	65,0	65,0	66,0
k	71,5	80,0	86,0	91,0	91,0	99,0
l ø	45,0	45,0	55,0	60,0	60,0	60,0
m	3,5	7,0	11,5	12,0	12,0	17,0
Leiter mm ² min	1,5	1,5	1,5	2,5	2,5	2,5
Leiter mm ² max	4	4	4	10	10	10