

panel mounting socket outlet, straight - flange 75x75,
fixing centers 60x60



Product description	
BALS-Prd.-Nr	13850
EAN	4024941138505
Product category	Panel mounting socket outlet Quick-Connect, straight
Current	32A
Number of poles	5p
Arrangement of phases	3p+N+PE
Position of earth contact	6 h
Voltage	200/346 - 240/415V~

Product description	
Frequency	50/60Hz
Protection degree	IP44
Colour code	red RAL 3000
Colour of appliance	Hinged lid red RAL 3000, Enclosure grey RAL 7035
Connection design	screwless spring terminals with Kontex-Kontakt
Maximum conductor size	10,0 qmm
Cable entry	other
Height	99mm
Width	75mm
Depth	116mm
Flange size vertical in mm	75mm
Flange size horizontal in mm	75mm
Drill hole dist. vertical mm	60mm
Drill hole dist. horizontal mm	60mm
Material of enclosure	Polyamide
Contacts	The contact carrier is made of polyamide, The contacts are brass

Logistics data	
Weight/pcs	0.214 kg / Piece
Packaging	Bag
Content amount	1 ST

Logistics data	
EAN	4024941138505
Length	116 mm
Width	75 mm
Height	99 mm
Weight	0.215 kg
Volume	861.3 ccm
Packaging	Carton
Content amount	10 ST
EAN	4024941962919
Length	258 mm
Width	183 mm
Height	212 mm
Weight	2.292 kg
Volume	8,750 ccm

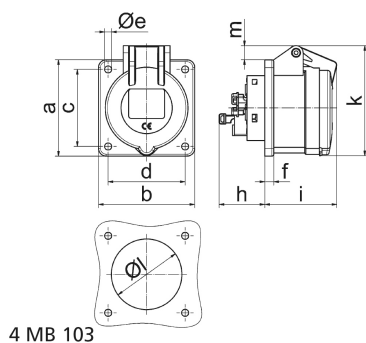

Ampere Polzahl	16 3	16 4	16 5	32 3	32 4	32 5
a	75,0	75,0	75,0	75,0	75,0	75,0
b	75,0	75,0	75,0	75,0	75,0	75,0
c	60,0	60,0	60,0	60,0	60,0	60,0
d	60,0	60,0	60,0	60,0	60,0	60,0
e ø	5,5	5,5	5,5	5,5	5,5	5,5
f	7,0	7,0	7,0	8,0	8,0	8,0
h	35,5	35,5	35,5	50,0	50,0	50,0
i	52,0	53,0	57,0	65,0	65,0	66,0
k	71,5	80,0	86,0	91,0	91,0	99,0
l ø	45,0	45,0	55,0	60,0	60,0	60,0
m	3,5	7,0	11,5	12,0	12,0	17,0
Leiter mm ² min	1,5	1,5	1,5	2,5	2,5	2,5
Leiter mm ² max	4	4	4	10	10	10