

Wall mounting socket outlet fused - with C-type circuit breaker 225x118



Product description	
BALS-Prd.-Nr	1595
EAN	4024941015950
Product category	QUICK-CONNECT TE wall mounting socket outlet, fused
Current	16A
Number of poles	5p
Arrangement of phases	3p+N+PE
Position of earth contact	6 h
Voltage	200/346 - 240/415V~

Product description	
Frequency	50/60Hz
Protection degree	IP44
Colour code	red RAL 3000
Colour of appliance	Operating window smoky topaz, Hinged lid red RAL 3000, Housing screws grey RAL 7035, Housing bottom grey RAL 7035, Housing top grey RAL 7035
Connection design	screwless spring terminals with KONTEX-contact
Maximum conductor size	4,0 qmm
Cable entry	top entry M25/M25 bottom entry M25
Height	243mm
Width	118mm
Depth	130mm
Dimension of enclosure	225x118 mm (HxW)
Material of enclosure	Polycarbonate
Contacts	the contact carrier is made of high temperature resistant material, the contacts are brass nickel plated

Additional technical information	
	The cable entry is one at top open, one at top is closed, and two at bottom are closed
	With 3 pole C-type MCB

Logistics data	
Weight/pcs	0.0 kg / Piece

Logistics data	
Packaging	Carton
Content amount	1 ST
EAN	4024941015950
Length	275 mm
Width	175 mm
Height	137 mm
Weight	0.125 kg
Volume	5,737.5 ccm

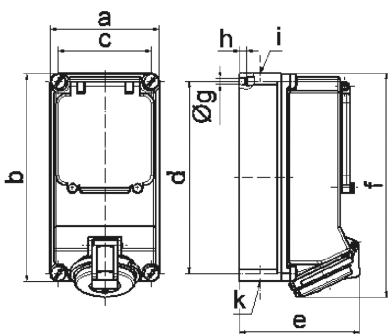

14 MB 13

Ampere	16	16	32	32	32
Polzahl	4	5	3	4	5
a	118,0	118,0	118,0	118,0	118,0
b	225,0	225,0	225,0	225,0	225,0
c	101,0	101,0	101,0	101,0	101,0
d	208,0	208,0	208,0	208,0	208,0
e	123,0	130,0	134,0	134,0	141,0
f	242,0	242,0	250,0	250,0	250,0
g	6,5	6,5	6,5	6,5	6,5
h ø	8,0	8,0	8,0	8,0	8,0
i	2 x M25	2 x M25	2 x M25	2 x M25	2 x M25
k	2 x M25	2 x M25	2 x M25	2 x M25	2 x M25