

## wall mounting socket outlet, switched, interlocked - housing dimensions 170x90



Product description	
BALS-Prd.-Nr	1619
EAN	4024941016193
Product category	Wall mounting socket outlet, switched, interlocked
Current	16A
Number of poles	3p
Arrangement of phases	2P+PE
Position of earth contact	6 h
Voltage	200 - 250V~

Product description	
Frequency	50/60Hz
Protection degree	IP44
Colour code	blue RAL 5015
Colour of appliance	Hinged lid blue RAL 5015, Housing bottom grey RAL 7035, Housing top grey RAL 7035, Control knob grey RAL 7035
Connection design	screwless spring terminals with Kontex-Kontakt
Maximum conductor size	4,0 qmm
Cable entry	top entry M20 bottom entry M25/20
Height	188mm
Width	90mm
Depth	108mm
Dimension of enclosure	170x90 mm (HxW)
Material of enclosure	Polycarbonate
Contacts	the contacts are brass nickel plated, The contact carrier is made of polyamide

Additional technical information	
	The cable entry is one at top open and two at bottom closed
	Lower part of housing rotatable by 180°, In 0-position lockable for 3 padlocks with bow diameter up to 7 mm

Logistics data	
Weight/pcs	0.575 kg / Piece

Logistics data	
Packaging	Carton
Content amount	1 ST
EAN	4024941016193
Length	205 mm
Width	102 mm
Height	134 mm
Weight	0.635 kg
Volume	2,118.48 ccm

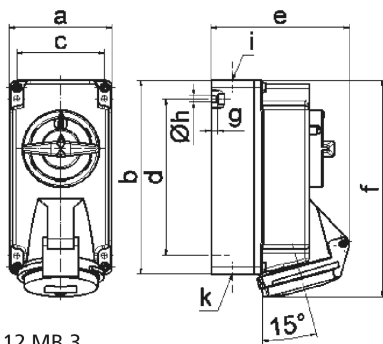

12 MB 3

Ampere	16	16	16			
Polzahl	3	4	5			
a	90,0	90,0	90,0			
b	170,0	170,0	170,0			
c	77,0	77,0	77,0			
d	137,5	137,5	137,5			
e	108,0	114,0	121,0			
f	188,5	188,5	190,0			
g	6,0	6,0	6,0			
h ø	5,5	5,5	5,5			
i	M20	M20	M20			
k	M20/25	M20/25	M20/25			