

wall mounting socket outlet, switched, interlocked - housing dimensions 460x180



Product description	
BALS-Prd.-Nr	16620
EAN	4024941166201
Product category	TE wall mounting socket outlet, switched, interlocked
Current	125A
Number of poles	3p
Arrangement of phases	2P+PE
Position of earth contact	6 h
Voltage	200 - 250V~

Product description	
Frequency	50/60Hz
Protection degree	IP67
Colour code	blue RAL 5015
Colour of appliance	Hinged lid blue RAL 5015, Housing bottom grey RAL 7035, Housing screws grey RAL 7035, Housing top grey RAL 7035, Bayonet ring grey RAL 7035, Control knob grey RAL 7035
Connection design	screw terminal as box terminal with Kontex-contact
Maximum conductor size	70 mm ² (possible limitation by the used cable entry)
Cable entry	top entry M40 bottom entry M50/M40
Height	512mm
Width	180mm
Depth	210mm
Dimension of enclosure	460x180 mm (HxW)
Material of enclosure	Polycarbonate
Contacts	The contact carrier is made of high temperature resistant material, the contacts are brass nickel plated

Additional technical information	
	The cable entry is one at top and two at bottom open
	In 0-position lockable for 4 padlocks with bow diameter up to 7 mm

Logistics data	
Weight/pcs	3.648 kg / Piece

Logistics data	
Packaging	Carton
Content amount	1 ST
EAN	4024941166201
Length	560 mm
Width	215 mm
Height	260 mm
Weight	4.11 kg
Volume	26,400 ccm

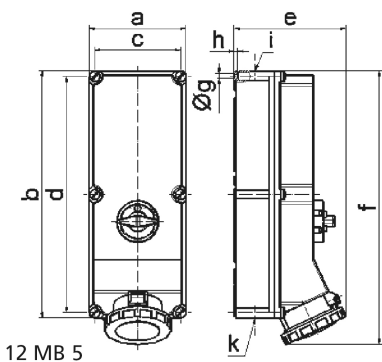

Ampere Polzahl	125 3	125 4	125 5
a	180,0	180,0	180,0
b	460,0	460,0	460,0
c	160,0	160,0	160,0
d	440,0	440,0	440,0
e	208,0	208,0	208,0
f	510,0	510,0	510,0
g ø	8,3	8,3	8,3
h	6,5	6,5	6,5
i	M40	M40	M40
k	M40/50	M40/50	M40/50