

Plug - with screw terminals one piece housing



Product description	
BALS-Prd.-Nr	21014-TLS
EAN	4024941193405
Product category	TLS plug with MULTI-GRIP cable gland
Current	32A
Number of poles	3p
Arrangement of phases	2P+PE
Position of earth contact	9 h
Voltage	380 - 415V~
Frequency	50/60Hz

Product description	
Protection degree	IP44
Colour code	red RAL 3000
Colour of appliance	Enclosure red RAL 3000, Cable gland grey RAL 7035
Connection design	with screw terminal
Maximum conductor size	6,0 qmm
Cable entry	with cable gland
Height	167mm
Width	71mm
Depth	81mm
Material of enclosure	Polyamide
Contacts	the contact carrier is made of polyamide, the contacts are brass

Additional technical information	
	one piece housing, MULTI-GRIP cable gland with gasket and integrated strain relief, For cable diameter from 11 up to max. 23,5 mm

Logistics data	
Weight/pcs	0.199 kg / Piece
Packaging	Bag
Content amount	1 ST
EAN	4024941193405
Length	81 mm

Logistics data	
Width	71 mm
Height	167 mm
Weight	0.2 kg
Volume	960.417 ccm
Packaging	Carton
Content amount	10 ST
EAN	4024941841597
Length	245 mm
Width	177 mm
Height	185 mm
Weight	2.123 kg
Volume	7,140 ccm

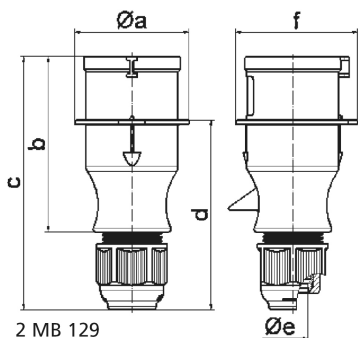

Ampere	16	16	16	32	32	32
Polzahl	3	4	5	3	4	5
a ø	54,0	60,0	66,0	71,0	71,0	80,0
b	94,5	98,0	101,0	115,0	115,0	119,0
c	138,0	142,0	145,0	170,0	170,0	174,0
d	101,5	105,5	108,5	124,0	124,0	128,0
e ø	18,0	18,0	18,0	23,0	23,0	23,0
f	56,6	64,0	71,0	76,0	76,0	85,0
Leiter mm ² min	1	1	1	2,5	2,5	2,5
Leiter mm ² max	2,5	2,5	2,5	6	6	6