

Plug - with screw terminals one piece housing



Product description	
BALS-Prd.-Nr	210600
EAN	4024941097000
Product category	TLS plug with MULTI-GRIP cable gland
Current	32A
Number of poles	4p
Arrangement of phases	3P+PE
Position of earth contact	9 h
Voltage	200 - 250V~
Frequency	50/60Hz

Product description	
Protection degree	IP67
Colour code	blue RAL 5015
Colour of appliance	Enclosure blue RAL 5015, Bayonet ring grey RAL 7035, Cable gland grey RAL 7035
Connection design	with screw terminal
Maximum conductor size	6,0 qmm
Cable entry	with cable gland
Height	170mm
Width	94mm
Depth	94mm
Material of enclosure	Polyamide
Contacts	the contact carrier is made of polyamide, the contacts are brass nickel plated

Additional technical information	
	one piece housing, MULTI-GRIP cable gland with gasket and integrated strain relief, For cable diameter from 11 up to max. 23,5 mm

Logistics data	
Weight/pcs	0.245 kg / Piece
Packaging	Bag
Content amount	1 ST
EAN	4024941097000

Logistics data	
Length	94 mm
Width	94 mm
Height	170 mm
Weight	0.246 kg
Volume	1,502.12 ccm
Packaging	Carton
Content amount	10 ST
EAN	4024941825320
Length	325 mm
Width	217 mm
Height	210 mm
Weight	2.656 kg
Volume	13,588.4 ccm

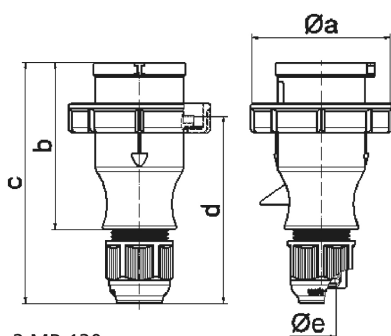

Ampere	16	16	16	32	32	32
Polzahl	3	4	5	3	4	5
a ø	70,0	78,0	86,0	94,0	94,0	101,0
b	94,5	98,0	101,0	115,0	115,0	119,0
c	138,0	142,0	145,0	170,0	170,0	174,0
d	105,5	109,5	112,5	128,0	128,0	132,0
e ø	18,0	18,0	18,0	23,0	23,0	23,0
Leiter mm² min	1	1	1	2,5	2,5	2,5
Leiter mm² max	2,5	2,5	2,5	6	6	6