

plug - with TE screw terminals, for harsh applications

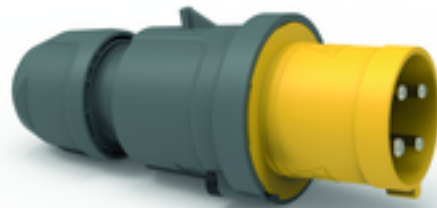

Product description	
BALS-Prd.-Nr	2149
EAN	4024941021494
Product category	TE plug
Current	63A
Number of poles	4p
Arrangement of phases	3P+PE
Position of earth contact	4 h
Voltage	100 - 130V~
Frequency	50/60Hz

Product description	
Protection degree	IP44
Colour code	yellow RAL 1012
Colour of appliance	Collar yellow RAL 1012, Pusher black RAL 9005, Housing cover dark grey RAL 7012, Cable gland dark grey RAL 7012
Connection design	screw terminal as box terminal
Maximum conductor size	16,0 qmm
Cable entry	with cable gland
Height	234mm
Width	97mm
Depth	98mm
Material of enclosure	Polyamide
Contacts	The contact carrier is made of high temperature resistant material, the contacts are brass nickel plated

Additional technical information	
	Multi-Grip cable gland with gasket and integrated strain relief, For cable diameter from 16 up to max. 36 mm, Screwless housing connection

Logistics data	
Weight/pcs	0.6 kg / Piece
Packaging	Bag
Content amount	1 ST
EAN	4024941021494

Logistics data	
Length	98 mm
Width	97 mm
Height	234 mm
Weight	0.601 kg
Volume	2,224.404 ccm
Packaging	Carton
Content amount	5 ST
EAN	4024941818674
Length	325 mm
Width	217 mm
Height	210 mm
Weight	3.206 kg
Volume	13,588.4 ccm

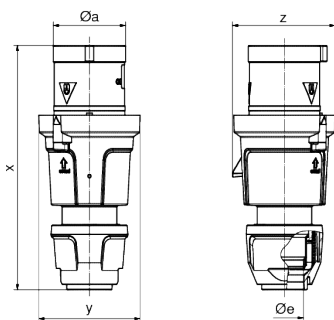

	63	63	63
Ampere	63	63	63
Polzahl	3	4	5
ø a	69,0	69,0	69,0
ø e	36,0	36,0	36,0
x	233,0	233,0	233,0
y	97,0	97,0	97,0
z	98,0	98,0	98,0
Cond. mm² min	6,0	6,0	6,0
Cond. mm² max	16,0	16,0	16,0



