

Plug - with TE screw terminals for harsh applications



Product description	
BALS-Prd.-Nr	21531
EAN	4024941215312
Product category	TE plug
Current	63A
Number of poles	3p
Arrangement of phases	2P+PE
Position of earth contact	10 h
Voltage	> 50V~
Frequency	100 - 300Hz

Product description	
Protection degree	IP44
Colour code	green RAL 6002
Colour of appliance	Pusher grey RAL 7035, Housing cover grey RAL 7035, Cable gland grey RAL 7035, Collar green RAL 6002
Connection design	screw terminal as box terminal
Maximum conductor size	16,0 qmm
Cable entry	with cable gland
Height	234mm
Width	97mm
Depth	98mm
Material of enclosure	Polyamide
Contacts	the contact carrier is made of high temperature resistant material, the contacts are brass nickel plated

Additional technical information	
	For cable diameter from 16 up to max. 36 mm, Screwless housing connection, MULTI-GRIP cable gland with gasket, integrated cable clamp and additional water evacuation openings

Logistics data	
Weight/pcs	0.61 kg / Piece
Packaging	Bag
Content amount	1 ST

Logistics data	
EAN	4024941215312
Length	98 mm
Width	97 mm
Height	234 mm
Weight	0.611 kg
Volume	2,224.404 ccm
Packaging	Carton
Content amount	5 ST
EAN	4024941831819
Length	325 mm
Width	217 mm
Height	210 mm
Weight	3.256 kg
Volume	13,588.4 ccm

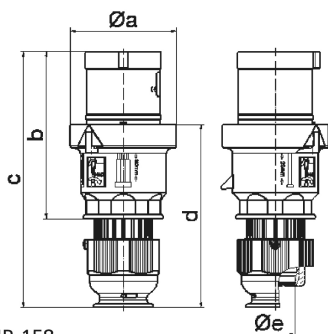

2 MB 158

Ampere	63	63	63				
Polzahl	3	4	5				
a ø	96,0	96,0	96,0				
b	153,0	153,0	153,0				
c	233,0	233,0	233,0				
d	167,0	167,0	167,0				
e ø	36,0	36,0	36,0				
Leiter mm ² min	6	6	6				
Leiter mm ² max	16	16	16				

