

Plug - with TE screw terminals for harsh applications



Product description	
BALS-Prd.-Nr	2180
EAN	4024941021807
Product category	TE plug
Current	63A
Number of poles	3p
Arrangement of phases	2P+PE
Position of earth contact	4 h
Voltage	100 - 130V~
Frequency	50/60Hz

Product description	
Protection degree	IP67
Colour code	yellow RAL 1012
Colour of appliance	Collar yellow RAL 1012, Pusher grey RAL 7035, Housing cover grey RAL 7035, Cable gland grey RAL 7035
Connection design	screw terminal as box terminal
Maximum conductor size	16,0 qmm
Cable entry	with cable gland
Height	234mm
Width	114mm
Depth	114mm
Material of enclosure	Polyamide
Contacts	the contact carrier is made of high temperature resistant material, the contacts are brass nickel plated

Additional technical information	
	For cable diameter from 16 up to max. 36 mm, Screwless housing connection, MULTI-GRIP cable gland with gasket, integrated cable clamp and additional water evacuation openings

Logistics data	
Weight/pcs	0.596 kg / Piece
Packaging	Bag
Content amount	1 ST

Logistics data	
EAN	4024941021807
Length	114 mm
Width	114 mm
Height	234 mm
Weight	0.597 kg
Volume	3,041.064 ccm
Packaging	Carton
Content amount	5 ST
EAN	4024941818698
Length	325 mm
Width	217 mm
Height	210 mm
Weight	3.186 kg
Volume	13,588.4 ccm

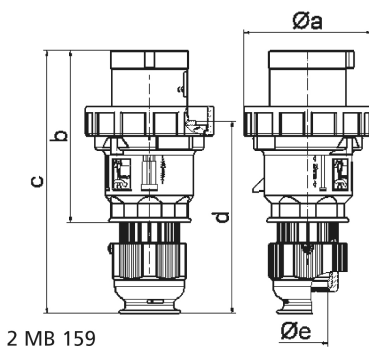

Ampere Polzahl	63 3	63 4	63 5				
a ø	113,5	113,5	113,5				
b	153,0	153,0	153,0				
c	233,0	233,0	233,0				
d	171,0	171,0	171,0				
e ø	36,0	36,0	36,0				
Leiter mm² min	6	6	6				
Leiter mm² max	16	16	16				