

plug - with TE screw terminals, for harsh applications



Product description	
BALS-Prd.-Nr	2194
EAN	4024941021944
Product category	TE plug
Current	125A
Number of poles	4p
Arrangement of phases	3P+PE
Position of earth contact	9 h
Voltage	200 - 250V~
Frequency	50/60Hz

Product description	
Protection degree	IP67
Colour code	blue RAL 5015
Colour of appliance	Collar blue RAL 5015, Pusher black RAL 9005, Housing cover dark grey RAL 7012, Cable gland dark grey RAL 7012, Bajonet ring dark grey RAL 7012
Connection design	screw terminal as box terminal
Maximum conductor size	50.0 qmm
Cable entry	with cable gland
Height	273mm
Width	126mm
Depth	126mm
Material of enclosure	Polyamide
Contacts	The contact carrier is made of high temperature resistant material, the contacts are brass nickel plated

Additional technical information	
	For cable diameter from 26 up to max. 50 mm, Multi-Grip cable gland with gasket and integrated strain relief, Screwless housing connection

Logistics data	
Weight/pcs	1.135 kg / Piece
Packaging	Bag
Content amount	1 ST
EAN	4024941021944

Logistics data	
Length	126 mm
Width	126 mm
Height	273 mm
Weight	1.136 kg
Volume	4,334.148 ccm
Packaging	Carton
Content amount	5 ST
EAN	4024941818759
Length	345 mm
Width	345 mm
Height	217 mm
Weight	6.01 kg
Volume	24,276 ccm

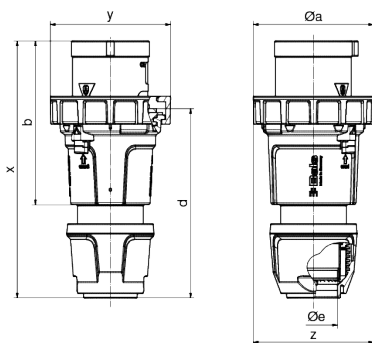

Ampere Polzahl	125 3	125 4	125 5
ø a	126,0	126,0	126,0
b	171,0	171,0	171,0
d	198,0	198,0	198,0
ø e	50,0	50,0	50,0
x	268,0	268,0	268,0
y	126,0	126,0	126,0
z	126,0	126,0	126,0
Cond. mm ² min	16,0	16,0	16,0
Cond. mm ² max	50,0	50,0	50,0



