

Panel mounting appliance inlet - without hinged cover



Product description	
BALS-Prd.-Nr	2664
EAN	4024941026642
Product category	Surface mounting appliance inlet
Current	32A
Number of poles	4p
Arrangement of phases	3P+PE
Position of earth contact	7 h
Voltage	480 - 500V~
Frequency	50/60Hz

Product description	
Protection degree	IP44
Colour code	black RAL 9005
Colour of appliance	Collar black RAL 9005, Enclosure grey RAL 7035
Connection design	with screw terminal
Maximum conductor size	6,0 qmm
Cable entry	other
Height	139mm
Width	90mm
Depth	86mm
Flange size vertical in mm	75mm
Flange size horizontal in mm	90mm
Drill hole dist. vertical mm	45mm
Drill hole dist. horizontal mm	78mm
Material of enclosure	Polyamide
Contacts	the contact carrier is made of polyamide, the contacts are brass

Logistics data	
Weight/pcs	0.235 kg / Piece
Packaging	Bag
Content amount	1 ST
EAN	4024941026642

Logistics data	
Length	86 mm
Width	90 mm
Height	139 mm
Weight	0.236 kg
Volume	1,075.86 ccm
Packaging	Carton
Content amount	10 ST
EAN	4024941833134
Length	295 mm
Width	185 mm
Height	215 mm
Weight	2.514 kg
Volume	9,975 ccm

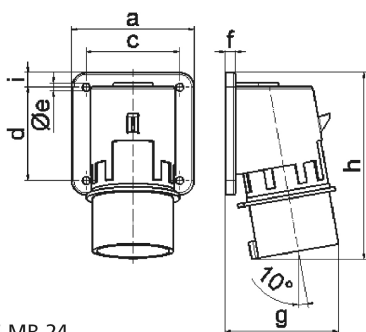

5 MB 24

Ampere	16	16	16	32	32	32
Polzahl	3	4	5	3	4	5
a	74,0	75,0	84,0	90,0	90,0	90,0
b	84,0	100,0	84,0	75,0	75,0	75,0
c	58,0	62,0	64,0	78,0	78,0	78,0
d	64,0	74,0	64,0	45,0	45,0	45,0
e ø	5,5	4,3	5,5	5,5	5,5	5,5
f	12,0	12,0	7,0	7,0	7,0	7,0
g	70,0	77,0	78,0	86,0	86,0	88,0
h	128,0	145,0	129,0	138,0	138,0	140,0
i	-	-	-	13,0	13,0	13,0
Leiter mm ² min	1	1	1	2,5	2,5	2,5
Leiter mm ² max	2,5	2,5	2,5	6	6	6