

Phase inverter as panel mounting socket inlet flange - straight - flange 85x85 fixing centers 70x70



Product description	
BALS-Prd.-Nr	28184
EAN	4024941281843
Product category	TE phase inverter as panel mounting appliance inlet straight
Current	32A
Number of poles	5p
Arrangement of phases	3p+N+PE
Position of earth contact	6 h
Voltage	200/346 - 240/415V~

Product description	
Frequency	50/60Hz
Protection degree	IP67
Colour code	red RAL 3000
Colour of appliance	Collar red RAL 3000, Bayonet ring grey RAL 7035, Enclosure grey RAL 7035
Connection design	with screw terminal
Maximum conductor size	6,0 qmm
Cable entry	other
Height	101.5mm
Width	101.5mm
Depth	86mm
Flange size vertical in mm	85mm
Flange size horizontal in mm	85mm
Drill hole dist. vertical mm	70mm
Drill hole dist. horizontal mm	70mm
Material of enclosure	Polyamide
Contacts	the contact carrier is made of high temperature resistant material, the contacts are brass nickel plated

Additional technical information	
	A retaining device to match the hinged cover of the connector must be provided to ensure the latching feature

Logistics data	
Weight/pcs	0.306 kg / Piece
Packaging	Bag
Content amount	1 ST
EAN	4024941281843
Length	86 mm
Width	101.5 mm
Height	101.5 mm
Weight	0.307 kg
Volume	885.994 ccm
Packaging	Carton
Content amount	10 ST
EAN	4024941823401
Length	295 mm
Width	185 mm
Height	215 mm
Weight	3.224 kg
Volume	9,975 ccm

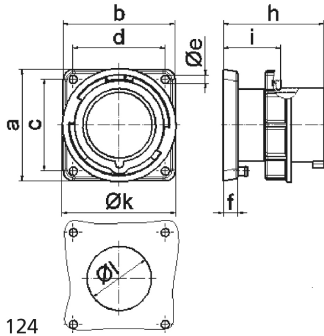

5 MB 124

Ampere	16	16	16	32	32	32
Polzahl	3	4	5	3	4	5
a	85,0	85,0	85,0	85,0	85,0	85,0
b	85,0	85,0	85,0	85,0	85,0	85,0
c	70,0	70,0	70,0	70,0	70,0	70,0
d	70,0	70,0	70,0	70,0	70,0	70,0
e ø	6,3	6,3	6,3	6,3	6,3	6,3
f	11,0	11,0	11,0	11,0	11,0	11,0
h	75,5	75,0	76,5	85,0	85,0	85,0
i	44,0	44,0	44,0	44,0	44,0	44,0
k	70,5	78,5	86,5	94,0	94,0	101,5
l ø	49,0	49,0	49,0	49,0	49,0	49,0
Leiter mm ² min	1	1	1	2,5	2,5	2,5
Leiter mm ² max	2,5	2,5	2,5	6	6	6