

Flanged appliance inlet - flange 110x106 fixing centers 90x90

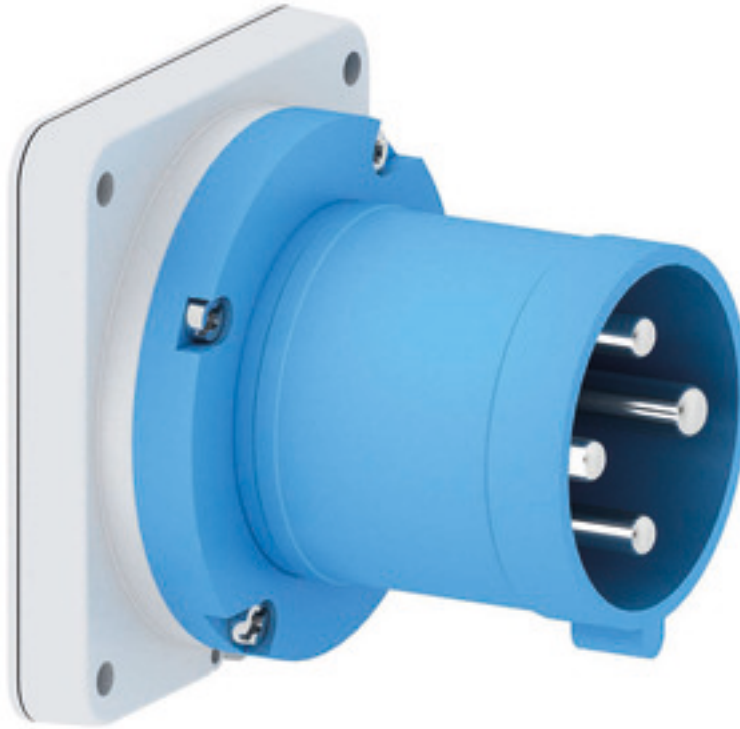

Product description	
BALS-Prd.-Nr	2841
EAN	4024941028417
Product category	TE flanged appliance inlet straight
Current	63A
Number of poles	4p
Arrangement of phases	3P+PE
Position of earth contact	9 h
Voltage	200 - 250V~

Product description	
Frequency	50/60Hz
Protection degree	IP44
Colour code	blue RAL 5015
Colour of appliance	Collar blue RAL 5015, Enclosure grey RAL 7035
Connection design	screw terminal as box terminal
Maximum conductor size	16,0 qmm
Cable entry	other
Height	105mm
Width	100mm
Depth	114mm
Flange size vertical in mm	110mm
Flange size horizontal in mm	106mm
Drill hole dist. vertical mm	90mm
Drill hole dist. horizontal mm	90mm
Material of enclosure	Polyamide
Contacts	the contact carrier is made of high temperature resistant material, the contacts are brass nickel plated

Additional technical information	
	A retaining device to match the hinged cover of the connector must be provided to ensure the latching feature
	Collar in middle of flange

Logistics data	
Weight/pcs	0.53 kg / Piece
Packaging	Bag
Content amount	1 ST
EAN	4024941028417
Length	114 mm
Width	100 mm
Height	105 mm
Weight	0.531 kg
Volume	1,197 ccm
Packaging	Carton
Content amount	5 ST
EAN	4024941950220
Length	258 mm
Width	183 mm
Height	212 mm
Weight	2.802 kg
Volume	8,750 ccm

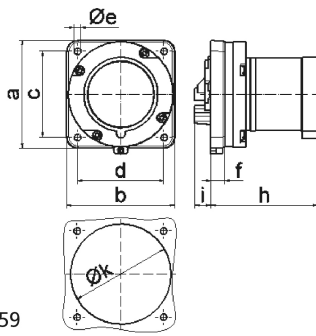

5 MB 59

Ampere	63	63	63			
Polzahl	3	4	5			
a	110,0	110,0	110,0			
b	106,0	106,0	106,0			
c	90,0	90,0	90,0			
d	90,0	90,0	90,0			
e ø	5,5	5,5	5,5			
f	13,0	13,0	13,0			
h	96,0	96,0	96,0			
i	19,0	19,0	19,0			
k	93,0	93,0	93,0			
Leiter mm ² min	6	6	6			
Leiter mm ² max	16	16	16			