

Connector - with screw terminals one piece housing



Product description	
BALS-Prd.-Nr	31005-TLS
EAN	4024941192378
Product category	TLS connector MULTI-GRIP cable gland
Current	16A
Number of poles	4p
Arrangement of phases	3P+PE
Position of earth contact	6 h
Voltage	380 - 415V~
Frequency	50/60Hz

Product description	
Protection degree	IP44
Colour code	red RAL 3000
Colour of appliance	Hinged lid red RAL 3000, Enclosure red RAL 3000, Cable gland grey RAL 7035
Connection design	with screw terminal
Maximum conductor size	2,5 qmm
Cable entry	with cable gland
Height	149mm
Width	52mm
Depth	74mm
Material of enclosure	Polyamide
Contacts	the contact carrier is made of polyamide, the contacts are brass

Additional technical information	
	one piece housing, MULTI-GRIP cable gland with gasket and integrated strain relief, For cable diameter from 8 up to max. 18 mm

Logistics data	
Weight/pcs	0.174 kg / Piece
Packaging	Bag
Content amount	1 ST
EAN	4024941192378

Logistics data	
Length	74 mm
Width	52 mm
Height	149 mm
Weight	0.175 kg
Volume	583.44 ccm
Packaging	Carton
Content amount	10 ST
EAN	4024941828222
Length	275 mm
Width	175 mm
Height	137 mm
Weight	1.865 kg
Volume	5,737.5 ccm

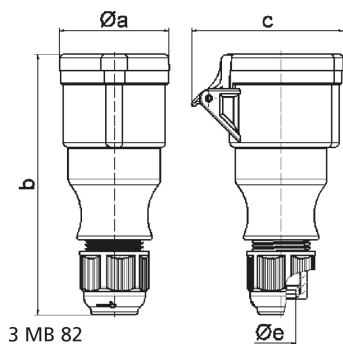

Ampere	16	16	16	32	32	32
Polzahl	3	4	5	3	4	5
a ø	51,0	58,0	65,0	67,0	67,0	73,0
b	145,0	148,0	156,0	185,0	185,0	185,0
c	74,0	84,0	90,0	94,0	94,0	102,0
e ø	18,0	18,0	18,0	23,0	23,0	23,0
Leiter mm ² min	1	1	1	2,5	2,5	2,5
Leiter mm ² max	2,5	2,5	2,5	6	6	6