

Connector TN - with cable gland with bayonet cover



Product description	
BALS-Prd.-Nr	310183
EAN	4024941108638
Product category	TN connector
Current	125A
Number of poles	4p
Arrangement of phases	3P+PE
Position of earth contact	2 h
Voltage	> 50V~
Frequency	> 300 - 500Hz

Product description	
VG-type-no.:	VG 96919 DS 037
Protection degree	IP67
Colour code	bronze-green RAL 6031-F9
Colour of appliance	Pusher black RAL 9005, Cable gland bronze-green RAL 6031-F9, Bayonet ring bronze-green RAL 6031-F9, Housing cover bronze-green RAL 6031-F9, Collar bronze-green RAL 6031-F9, Hinged lid bronze-green RAL 6031-F9
Connection design	screw terminal as box terminal with Kontex-contact
Maximum conductor size	50.0 qmm
Cable entry	with cable gland
Height	294mm
Width	125mm
Depth	129mm
Material of enclosure	Polyamide
Contacts	the contact carrier is made of high temperature resistant material, the contacts are brass nickel plated

Additional technical information	
	with pilot contact
	For cable diameter from 26 up to max. 50 mm, Screwless housing connection, MULTI-GRIP cable gland with gasket, integrated cable clamp and additional water evacuation openings
	With bayonet cover on strap

Logistics data	
Weight/pcs	0.0 kg / Piece
Packaging	Carton
Content amount	5 ST
EAN	4024941840118
Length	345 mm
Width	345 mm
Height	217 mm
Weight	0.335 kg
Volume	24,276 ccm

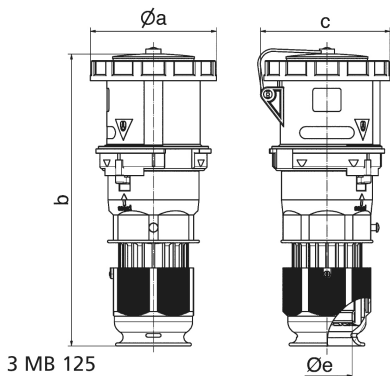

Ampere	63	63	63	125	125	125
Polzahl	3	4	5	3	4	5
a ø	110,0	110,0	110,0	125,0	125,0	125,0
b	263,0	263,0	263,0	300,0	300,0	300,0
c	113,0	113,0	113,0	128,0	128,0	128,0
d ø	36,0	36,0	36,0	50,0	50,0	50,0
Leiter mm ² min	6,0	6,0	6,0	16,0	16,0	16,0
Leiter mm ² max	16,0	16,0	16,0	50,0	50,0	50,0