

panel mounting socket outlet low voltage - straight execution, flange 55x55, fixing centers 45x45



Product description	
BALS-Prd.-Nr	432
EAN	4024941004329
Product category	ELV panel mounting socket outlet, straight
Current	16A
Number of poles	2p
Arrangement of phases	2P
Position of earth contact	4 h
Voltage	20 up to 25 and 40 up to 50V

Product description	
Frequency	100 - 200Hz
Protection degree	IP44
Colour code	green RAL 6002
Colour of appliance	Hinged lid green RAL 6002, Enclosure grey RAL 7035
Connection design	with screw terminal
Maximum conductor size	10,0 qmm
Cable entry	other
Height	67mm
Width	55mm
Depth	59mm
Flange size vertical in mm	55mm
Flange size horizontal in mm	55mm
Drill hole dist. vertical mm	45mm
Drill hole dist. horizontal mm	45mm
Material of enclosure	Polyamide
Contacts	The contact carrier is made of polyamide, the contacts are brass nickel plated

Logistics data	
Weight/pcs	0.11 kg / Piece
Packaging	Bag
Content amount	1 ST

Logistics data	
EAN	4024941004329
Length	59 mm
Width	55 mm
Height	67 mm
Weight	0.111 kg
Volume	1,746.154 ccm
Packaging	Carton
Content amount	10 ST
EAN	4024941836562
Length	207 mm
Width	162 mm
Height	142 mm
Weight	1.2 kg
Volume	3,750 ccm

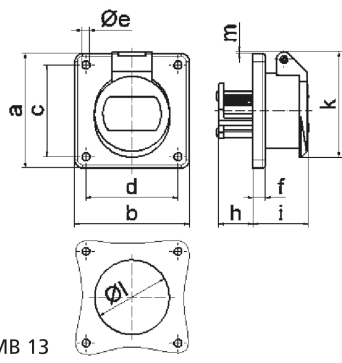

16 MB 13

Ampere	16	16	32	32		
Polzahl	2	3	2	3		
a	55,0	55,0	55,0	55,0		
b	55,0	55,0	55,0	55,0		
c	45,0	45,0	45,0	45,0		
d	45,0	45,0	45,0	45,0		
e ø	5,2	5,2	5,2	5,2		
f	6,0	6,0	6,0	6,0		
h	22,0	22,0	22,0	22,0		
i	37,0	37,0	37,0	37,0		
k	67,0	67,0	67,0	67,0		
l ø	49,0	49,0	49,0	49,0		
m	12,0	12,0	12,0	12,0		
Leiter mm ² min	4	4	4	4		
Leiter mm ² max	10	10	10	10		