

Panel mounting socket outlet low voltage - straight execution flange 70x70, fixing centers 56,5x56,5



Product description	
BALS-Prd.-Nr	4335
EAN	4024941043359
Product category	ELV panel mounting socket outlet, straight
Current	32A
Number of poles	2p
Arrangement of phases	2P
Position of earth contact	4 h
Voltage	20 up to 25 and 40 up to 50V

Product description	
Frequency	100 - 200Hz
Protection degree	IP44
Colour code	green RAL 6002
Colour of appliance	Hinged lid green RAL 6002, Enclosure grey RAL 7035
Connection design	with screw terminal
Maximum conductor size	10,0 qmm
Cable entry	other
Height	70mm
Width	70mm
Depth	60mm
Flange size vertical in mm	70mm
Flange size horizontal in mm	70mm
Drill hole dist. vertical mm	56.5mm
Drill hole dist. horizontal mm	56.5mm
Material of enclosure	Polyamide
Contacts	the contact carrier is made of polyamide, the contacts are brass nickel plated

Logistics data	
Weight/pcs	0.14 kg / Piece
Packaging	Bag
Content amount	1 ST

Logistics data	
EAN	4024941043359
Length	60 mm
Width	70 mm
Height	70 mm
Weight	0.141 kg
Volume	294 ccm

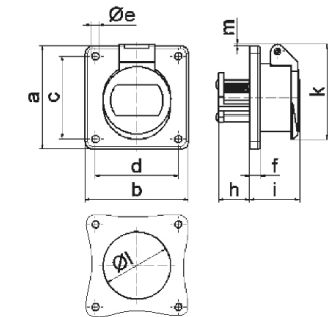

16 MB 21

Ampere	16	16	32	32			
Polzahl	2	3	2	3			
a	70,0	70,0	70,0	70,0			
b	70,0	70,0	70,0	70,0			
c	56,5	56,5	56,5	56,5			
d	56,5	56,5	56,5	56,5			
e ø	5,5	5,5	5,5	5,5			
f	8,0	8,0	8,0	8,0			
h	22,0	22,0	22,0	22,0			
i	37,0	37,0	37,0	37,0			
k	67,0	67,0	67,0	67,0			
l ø	49,0	49,0	49,0	49,0			
m	4,0	4,0	4,0	4,0			
Leiter mm ² min	4	4	4	4			
Leiter mm ² max	10	10	10	10			