

Surface-mounting distributor - rubber - MODBOX - MIDI



Product description	
BALS-Prd.-Nr	5401884
EAN	4024941005456
Product category	MODBOX - MIDI
Protection degree	IP44
Colour of appliance	Housing bottom similar black RAL 9017, Housing top similar black RAL 9017
Height	384mm
Width	225mm
Depth	135mm
RDF factor	0.6

Product description	
Nominal current InA	32

Logistics data	
Weight/pcs	10.858 kg / Piece
Packaging	Carton
Content amount	1 ST
EAN	4024941005456
Length	320 mm
Width	346 mm
Height	511 mm
Weight	11.568 kg
Volume	56,577.92 ccm

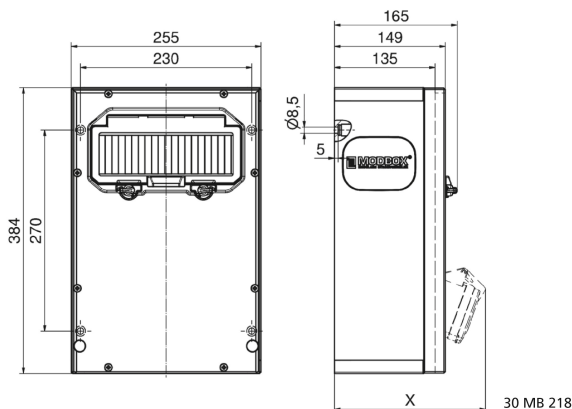
Tiefenmaß/ depth X (mm)

Bezeichnung/ with	IP44	IP67
OTC-Klappe/ OTC operating window	165	165
Schutzk. Steckdose/domestic socket	152	195
CEE 16A 3p	190	190
CEE 16A 4p	194	192
CEE 16A 5p	197	195
CEE 32A 3p/4p	201	203
CEE 32A 5p	203	204
CEE 63A 3p/4p/5p	219	221