

## Surface-mounting distributor - rubber - Distributor - solid rubber - wall mounting



Product description	
BALS-Prd.-Nr	5402054
EAN	4024941948739
Product category	Distributor, solid rubber, wall mounting
Specification/Norm	DIN EN 61439-2
Protection degree	IP44
Colour of appliance	Housing bottom similar black RAL 9017, Housing top similar black RAL 9017
Height	380mm
Width	370mm

Product description	
Depth	225mm
RDF factor	0.84
Nominal current InA	63

Logistics data	
Weight/pcs	13.206 kg / Piece
Packaging	Carton
Content amount	1 ST
EAN	4024941948739
Length	610 mm
Width	410 mm
Height	430 mm
Weight	14.312 kg
Volume	98,400 ccm

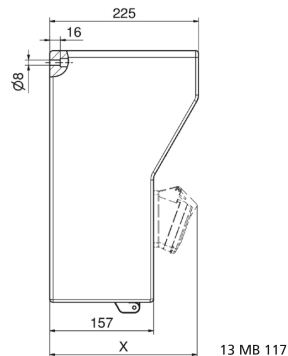
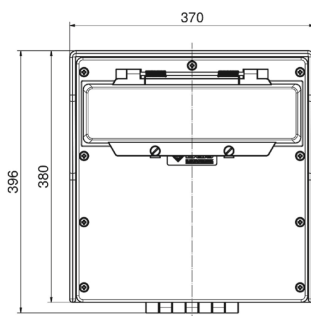
**Tiefenmaß/ depth X (mm)**

Bezeichnung/ with	IP44	IP67
Schutzk. Steckdose/domestic socket	172	215
CEE 16A 3p	210	210
CEE 16A 4p	214	212
CEE 16A 5p	217	215
CEE 32A 3p/4p	221	223
CEE 32A 5p	223	224
CEE 63A 3p/4p/5p	239	241