

## Surface-mounting distributor - rubber



Product description	
BALS-Prd.-Nr	5402787
EAN	4024941979733
Product category	MODBOX
Specification/Norm	DIN EN 61439-3
Protection degree	IP67
Colour of appliance	Housing bottom similar black RAL 9017, Housing top similar black RAL 9017
Height	420mm
Width	300mm
Depth	200mm

Product description	
RDF factor	0.91
Nominal current InA	32

Logistics data	
Weight/pcs	13.5 kg / Piece
Packaging	Carton
Content amount	1 ST
EAN	4024941979733
Length	320 mm
Width	346 mm
Height	511 mm
Weight	14.21 kg
Volume	56,577.92 ccm

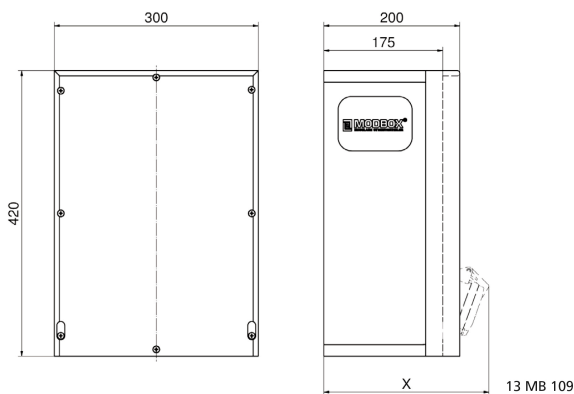
**Tiefenmaß/ depth X (mm)**

Bezeichnung/ with	IP44	IP67
Schutzk. Steckdose/domestic socket	192	235
CEE 16A 3p	230	230
CEE 16A 4p	234	232
CEE 16A 5p	237	235
CEE 32A 3p/4p	241	243
CEE 32A 5p	243	244
CEE 63A 3p/4p/5p	259	261