

Cross distributors - Cross distributor



Product description	
BALS-Prd.-Nr	54741
EAN	4024941947657
Product category	Cross distributor
Specification/Norm	DIN EN 61439-2
Protection degree	IP44
Colour of appliance	Housing bottom grey RAL 7035, Housing top grey RAL 7035
Height	118mm
Width	118mm
Depth	80mm

Product description	
RDF factor	0.9
Nominal current InA	16

Logistics data	
Weight/pcs	0.572 kg / Piece
Packaging	Carton
Content amount	1 ST
EAN	4024941947657
Length	258 mm
Width	183 mm
Height	212 mm
Weight	0.721 kg
Volume	8,750 ccm

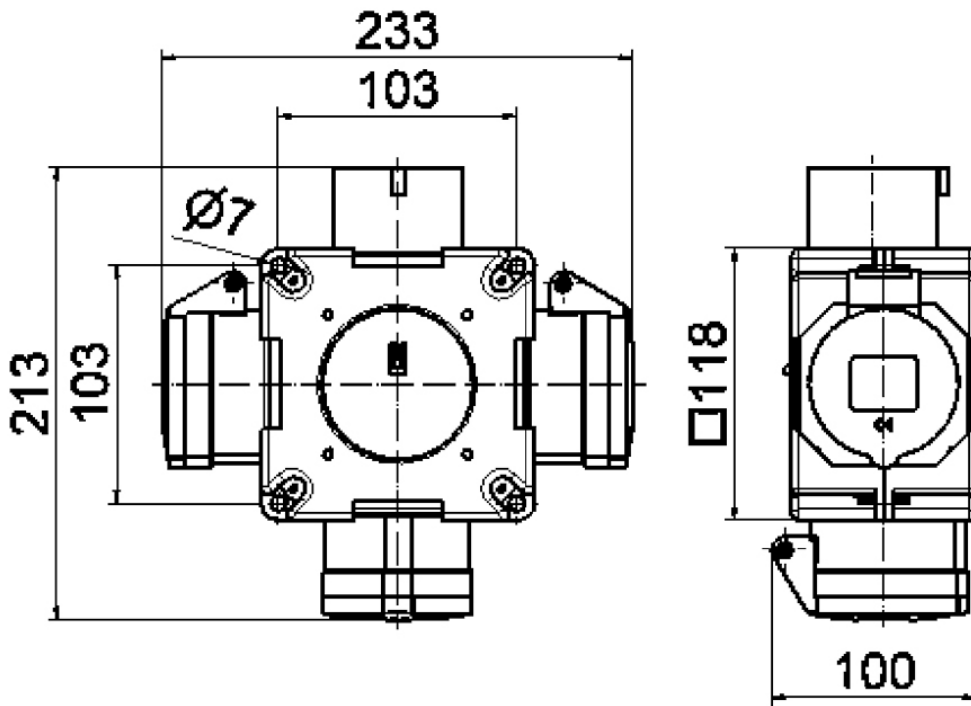

30 MB 061