

Surface-mounting distributor - plastic - VARIABOX - L Plus

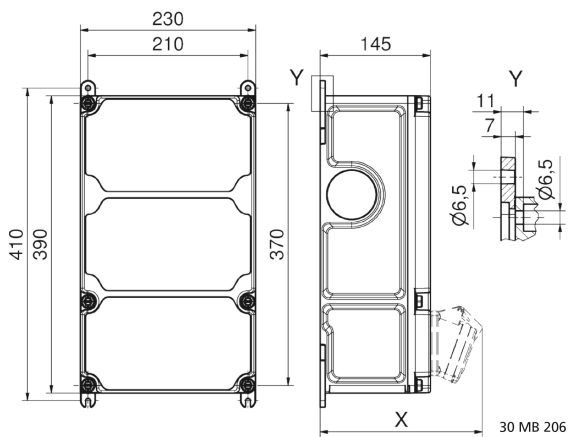

Product description	
BALS-Prd.-Nr	89194
EAN	4024941004893
Product category	VARIABOX - L Plus
Protection degree	IP54
Colour of appliance	Housing bottom similar black RAL 9017, Housing top grey RAL 7035
Height	390mm
Width	230mm
Depth	145mm

Logistics data	
Weight/pcs	5.172 kg / Piece
Packaging	Carton
Content amount	1 ST
EAN	4024941004893
Length	430 mm
Width	270 mm
Height	255 mm
Weight	5.475 kg
Volume	29,605.5 ccm

Tiefenmaß/ depth X (mm)

Bezeichnung/ with	IP44	IP67
OTC-Klappe/ OTC operating window	180	180
Schutzk. Steckdose/domestic socket	162	205
CEE 16A 3p	200	200
CEE 16A 4p	204	202
CEE 16A 5p	207	205
CEE 32A 3p/4p	211	213
CEE 32A 5p	213	214
CEE 63A 3p/4p/5p	229	231