

Surface-mounting distributor - plastic



Product description	
BALS-Prd.-Nr	893552
EAN	4024941853408
Product category	VARIABOX - L
Specification/Norm	DIN EN 61439-3
Protection degree	IP44
Colour of appliance	Housing bottom similar black RAL 9017, Housing top grey RAL 7035
Height	390mm
Width	230mm
Depth	145mm

Product description	
RDF factor	0.58
Nominal current InA	63

Logistics data	
Weight/pcs	5.902 kg / Piece
Packaging	Carton
Content amount	1 ST
EAN	4024941853408
Length	430 mm
Width	270 mm
Height	255 mm
Weight	6.205 kg
Volume	29,605.5 ccm

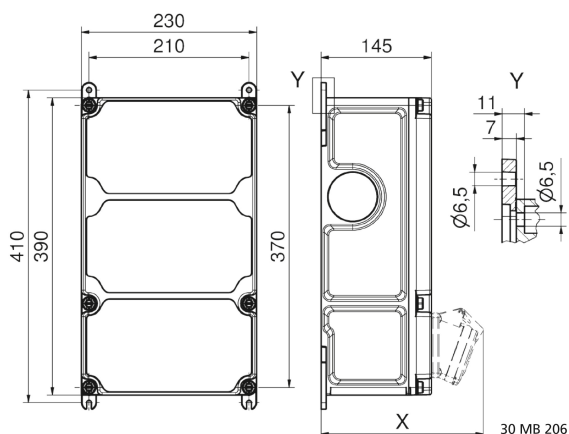
Tiefenmaß/ depth X (mm)

Bezeichnung/ with	IP44	IP67
OTC-Klappe/ OTC operating window	180	180
Schutzk. Steckdose/domestic socket	162	205
CEE 16A 3p	200	200
CEE 16A 4p	204	202
CEE 16A 5p	207	205
CEE 32A 3p/4p	211	213
CEE 32A 5p	213	214
CEE 63A 3p/4p/5p	229	231